

hotflex®

Flexible tubular heater

- Easy installation with a uniform finish
- Can be formed by hand
- Stored in a straight condition to save storage space
- No special installation tools required
- Patented technology ensures industry leading heat transfer
- Up to 75% sheath contact with round and square hotflex heaters when recommended groove geometry is followed
- Rapid heat-up times
- Minimal temperature difference between heater sheath and heated tool
- 3-dimensional groove geometry possible
- Industry's smallest bending radius
- Hotflex's flexibility enables heat to be located where it is needed; an improvement over rigid cartridge heaters
- Reduced energy costs: tool mass can be reduced



Technical key features

Sheath material	stainless steel
Sheath temperature of heating element	max. 700 °C / 1290 °F
Standard connection voltage	230 V
High voltage test*	1000 V AC
Insulation resistance*	≥ 5 MΩ at 500 V DC
Leakage current*	< 0.5 mA at 253 V AC
Wattage tolerance	± 10%
Length tolerance	± 1.5%

* tested at environmental temperature

Options

- Bendable unheated zones
- Connection voltage from 12 V to 250 V
- Individual length
- Individual wattage
- Individual connection options

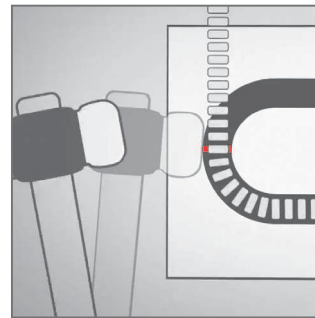

Installation without special tools



Ideal heat transfer

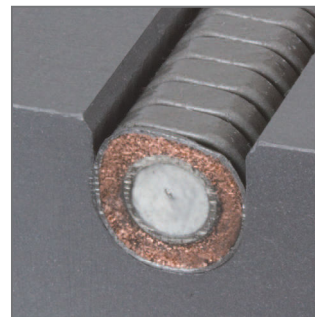

Installed, round groove geometry

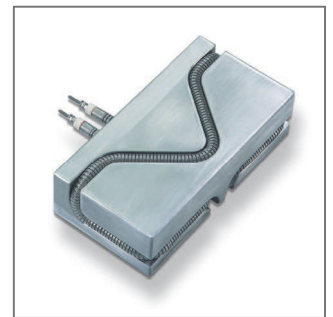

Installation example

Recommended groove geometry

Type hotflex	[mm] w x h	[mm] w x h
□ 6.0±0.1	6.1±0.1 x 7.1±0.1	
∅ 6.5±0.1	6.0±0.1 x 6.5±0.1	
∅ 8.0±0.1	7.7±0.05 x 8.0±0.1	
□ 8.0±0.1	8.1±0.1 x 9.1±0.1	
∅ 8.2±0.1	7.9±0.05 x 8.2±0.1	
∅ 8.5±0.1	8.2±0.05 x 8.5±0.1	
∅ 10.0±0.1	9.7±0.05 x 10.0±0.1	

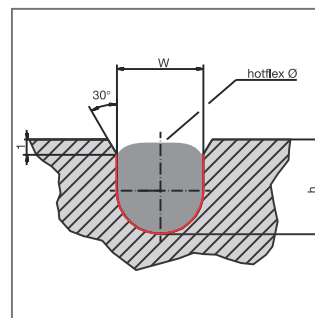

Round groove geometry

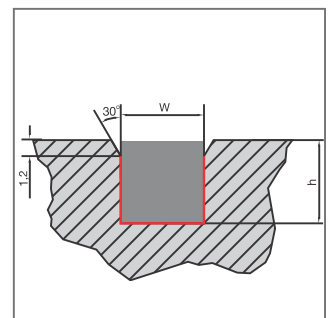

Square groove geometry

<p>Ceramic terminal connector "plug'n heat" Temp. restist. 230 °C / 445 °F Short term max. 280 °C / 535 °F 14 x 21 x 25 mm / 5,51 x 8,27 x 9,84" available with stock items</p>	<p>Standard: threaded pins M2.5 Option: M4 from Ø 8.0 mm with set of nuts and washers. Temp. restist. 350 °C / 660 °F</p>	<p>Plain Ni-leads with ceramic beads insulation, up to 600 °C / 1110 °F</p>	<p>Insulated Ni-leads Glass silk: up to 320 °C / 605 °F PTFE: up to 260 °C / 500 °F Silicon: up to 180 °C / 350 °F Option: eyelet connector M4 available with stock items</p>	<p>High temperature mineral fibre insulated Ni-leads, with ceramic sealed tube section</p>	<p>Flat plug W = 6.3 mm / 0.248 inch. Temp. restist. 350 °C / 660 °F available with stock items</p>
---	---	---	---	--	--

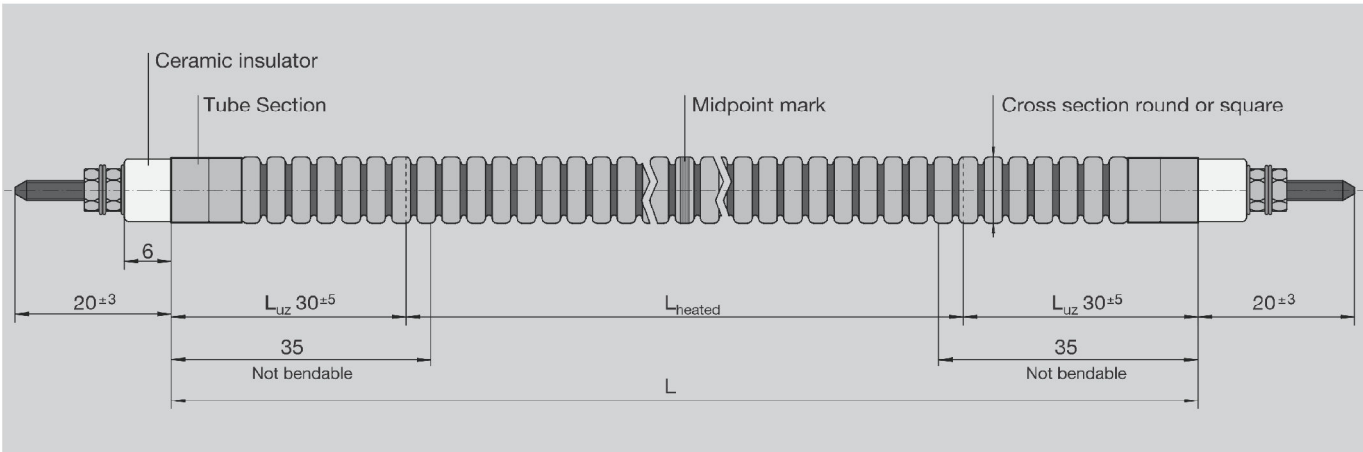
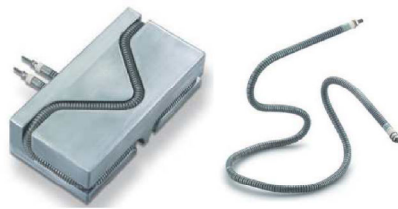

Recommended groove geometry

Type hotflex	[mm] w x h
□ 6.0 ^{±0.1}	6.1 ^{±0.1} x 7.1 ^{±0.1}
○ 6.5 ^{±0.1}	6.0 ^{±0.1} x 6.5 ^{±0.1}
○ 8.0 ^{±0.1}	7.7 ^{±0.05} x 8.0 ^{±0.1}
□ 8.0 ^{±0.1}	8.1 ^{±0.1} x 9.1 ^{±0.1}
○ 8.2 ^{±0.1}	7.9 ^{±0.05} x 8.2 ^{±0.1}
○ 8.5 ^{±0.1}	8.2 ^{±0.05} x 8.5 ^{±0.1}
○ 10.0 ^{±0.1}	9.7 ^{±0.05} x 10.0 ^{±0.1}

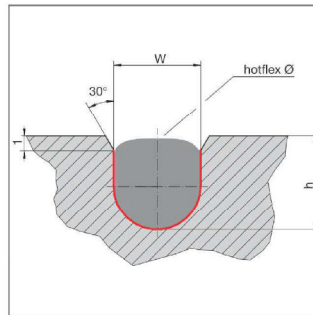

Round groove geometry

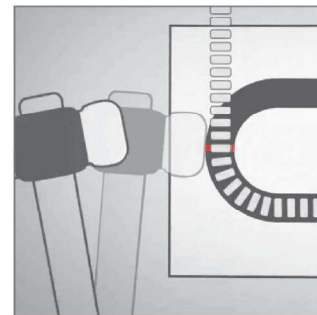

Installation without special tools

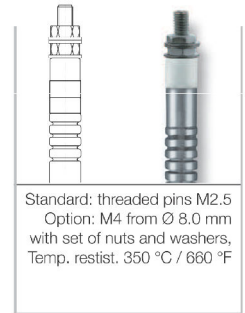

Standard: threaded pins M2.5
Option: M4 from Ø 8.0 mm
with set of nuts and washers,
Temp. resist. 350 °C / 660 °F

**Stock range Ø 6.5 mm (230 V)
with threaded pins M2.5**

Stock ID	L [mm]	P [W]
6500300	300	350
6500350	350	400
6500400	400	500
6500450	450	600
6500500	500	650
6500550	550	700
6500600	600	800
6500650	650	850
6500700	700	900
6500750	750	1000
6500800	800	1100
6500850	850	1200
6500900	900	1300
6500950	950	1350
6501000	1000	1400
6501050	1050	1450
6501100	1100	1500
6501150	1150	1550
6501200	1200	1600
6501250	1250	1650
6501300	1300	1700
6501350	1350	1800
6501400	1400	1900
6501450	1450	2000
6501500	1500	2100

**Stock range Ø 8.0 mm (240 V*)
with threaded pins M4**

Stock ID	L [mm]	P [W]
6300400	400	795
6300450	450	910
6300500	500	1025
6300550	550	1145
6300600	600	1260
6300650	650	1380
6300700	700	1495
6300750	750	1615
6300800	800	1730
6300850	850	1845
6300900	900	1960
6300950	950	2080
6301000	1000	2195
6301050	1050	2316
6301100	1100	2430
6301150	1150	2545
6301200	1200	2665
6301250	1250	2780
6301300	1300	2895
6301350	1350	3015
6301400	1400	3130
6301450	1450	3245
6301500	1500	3365
6301550	1550	3480
6301600	1600	3600

**Stock range Ø 8.5 mm (230 V)
with threaded pins M2.5**

Stock ID	L [mm]	P [W]
6100300	300	650
6100350	350	750
6100400	400	900
6100450	450	1050
6100500	500	1150
6100550	550	1300
6100600	600	1450
6100650	650	1600
6100700	700	1750
6100750	750	1900
6100800	800	2050
6100850	850	2200
6100900	900	2350
6100950	950	2500
6101000	1000	2650
6101050	1050	2800
6101100	1100	2930
6101150	1150	3060
6101200	1200	3190
6101250	1250	3320
6101300	1300	3450
6101350	1350	3580
6101400	1400	3710
6101450	1450	3840
6101500	1500	3970

**Stock range Ø 8.5 mm (230 V)
with threaded pins M2.5**

Stock ID	L [mm]	P [W]
6110500	500	700
6110550	550	780
6110600	600	860
6110650	650	950
6110700	700	1000
6110750	750	1100
6110800	800	1190
6110850	850	1250
6110900	900	1350
6110950	950	1430
6111000	1000	1500
6111050	1050	1590
6111100	1100	1650
6111150	1150	1750
6111200	1200	1830
6111250	1250	1900
6111300	1300	1990
6111350	1350	2070
6111400	1400	2150
6111450	1450	2230
6111500	1500	2300

* with connection voltage 230 V wattage will decrease by 8%.